

Article number: 0102226

Description: Retaining ring J480 DIN472
Spring steel

Measures

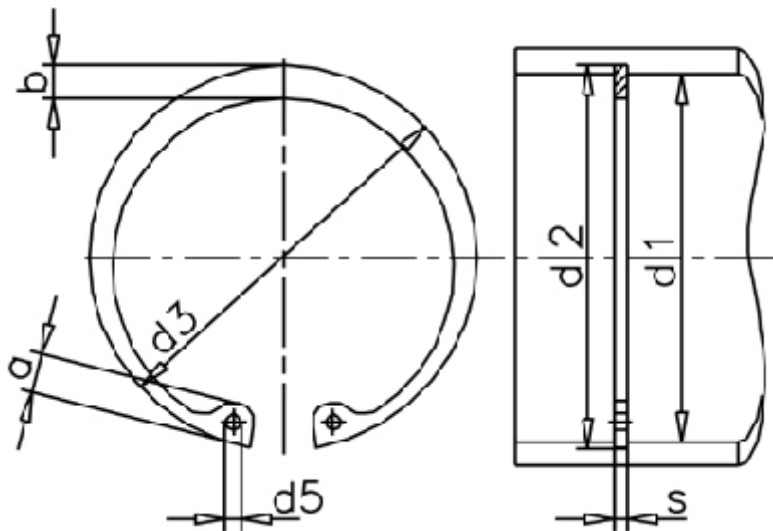

a max	=	FN kN	= 1526.00	t	= 6.00
AN mm ²	= 9161.0	FRg kN	= 130.0	tol	= +1,00
b	= 26.0	FR kN	= 1306.0	tol	= +2,00-1,00
d1	= 480	g	= 6.0	tol	= -0.15
d2	= 492.0	K kN-mm	= 2991.0	Tong	= ZGJ-5
d3	= 500.00	m min	= 7.20	Weight kg/1000	= 1640.00
d5 min	= 6.0	Nominal drive	= 18.0		
Description = J 480		s	= 7.00		